



深圳市龙圣电子有限公司

SHENZHEN UNIONTOP ELECTRONIC CO., LTD

PRODUCT:	Output 9V2.0A Wall Mount Switching Power Supply
MODEL:	UT18-090200U
PART NO:	
VER:	A/1
CUSTOMER:	
DATE:	

应用规格	电气用品安全法适合品
------	------------

返卻希望日: 年 月 日

发行印

受 领 印 栏	
------------------	--

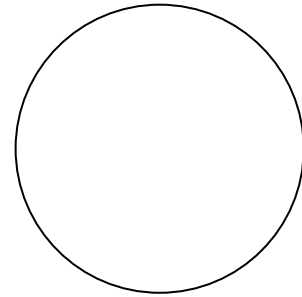

*未签回而下订单即视同认可!

生 产 工 厂

发 行 部 署							
工 程					品 管	业 务	
责 任 者		检 印		经 办			

NO.	变更年月日	变 更 内 容	检 印	担 当

CHINA TEL:+86-755-89600803 89797300 FAX:+86-755-89600969
 WEBSITE: www.uniontop.com.cn EMAILTO: uniontop@uniontop.com.cn
 工厂地址: 广东省深圳市布吉水经社区八约二街3号龙圣电子



DESCRIPTION

Switching Power
Supply

SHEET NO.

1 OF 10

VER:

A/1

MODEL NO.

UT18-090200U

PART NO.

- 1、 INPUT REQUIREMENT
- 2、 OUTPUT SPECIFICATION
- 3、 MECHANICAL
- 4、 RELIABILITY
- 5、 ENVIRONMENT
- 6、 OUTLOOKING
- 7、 SAFETY
- 8、 DIMENSION
- 9、 LABEL
- 10、 PACKING
- 11、 QC CHECK
- 12、 SAMPLE PRIMARY TEST REPORT
- 13、 SAMPLE TEST REPORT
- 14、 ENERGY STAR TEST REPORT

[Http:www.uniontop.com.cn](http://www.uniontop.com.cn)

CHINA TEL:+86-755-89600803 89797300 FAX:+86-755-89600969

1、 INPUT REQUIREMENT

ITEM	SPECIFCATION	MIN	TYP.	MAX
NORMAL AC INPUT VOLTAGE	SINGLE PHASE	100Vac	110Vac/220Vac	240Vac
AC INPUT VOLTAGE RANGE	SINGLE PHASE	90Vac	110Vac/220Vac	264Vac
AC INPUT FREQUENCY	SINGLE PHASE	47Hz	50/60Hz	63Hz
AC INPUT CURRENT	TYPICAL INPUT VOLTAGE&OUTPUT AT FULL LOAD.			500mA
AC INRUSH CURRENT	TYPICAL INPUT VOLTAGE&OUTPUT AT FULL LOAD, 25℃	30A		80A
EFFICIENCY	TYPICAL INPUT VOLTAGE&OUTPUT AT FULL LOAD.	65%		

2、 OUTPUT SPECIFICATION

ITEM	SPECIFCATION	MIN	TYP.	MAX
NORMAL DC OUTPUT VOLTAGE			9VDc	
DC OUTPUT VOLTAGE RANGE	TYPICAL OUTPUT VOLTAGE	8.55V		9.45V
LOAD CURRENT RANGE		0.0 A		2.0 A
PEAK LOAD CURRENT	TIME<60S			1 A
RIPPLE	TYPICAL INPUT VOLTAGE, TYPICAL LOAD CURRENT, 25℃			300mV
HOLD-UP TIME	AT TYPICAL INPUT VOLTAGE AND FULL LOAD	10ms		30ms
TURN-ON DELAY	TYPICAL INPUT VOLTAGE AND TOP LOAD CURRENT			3S
OVER CURRENT PROTECTION	AUTO RECOVERY			5 A
SHORT CIRCUIT PROTECTION	THE ADAPTER SHALL NOT DAMAGE BY SHORT THE DC OUTPUT TO GROUND			
OVER VOLTAGE PROTECTION			1V	1V
NO LOAD POWER DISSIPATION				0.5W

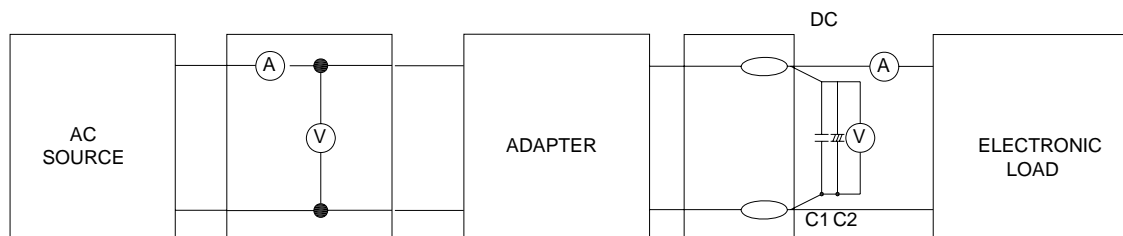
***TEST MEASURES**

C1 : 0.1uF CERAMICS CAPACITOR
 C2 : 10uF/50V ALUMINUM CAPACITOR



DESCRIPTION

Switching Power
Supply

SHEET NO.

3 OF 10

VER:

A/1

MODEL NO.

UT18-090200U

PART NO.

3、MECHANICAL

ITEM	SPECIFICATION OR TEST CONDITION	ACCEPTANCE CRITERIA
BENDING TEST	NORMAL TEMPERATURE THE CORD SHALL WITHSTAND WEIGHT OF 200g,SWINGING FROM LEFT TO RIGHT AT AN ANGLE OF 60 DEG. 1000CYCLE TIMES MIN. S/R SHALL WITHSTAND WEIGHT OF 1N. SWINGING FROM LEFT TO RIGHT AT AN ANGLE OF 60DEG. 1000CYCLE TIMES MIN. BENDING SPEED 40CYCLE/MINUTE	NO SHORT CIRCUIT NO BREAKAGE OF THE CORD
VIBRATION	FREQUENCY RANGE:10~55Hz AMPLITUDE:1.5mm ACCELERATION:1G SWEEP 1MINUTE FOR X,Y,Z,AXIS EACH	THERE SHALL BENO ABNORMALITY ON THE APPEARANCE STRUCTURE AND OPERATING

4、RELIABILITY

ITEM	SPECIFICATION OR TEST CONDITION	ACCEPTANCE CRITERIA
TEMPERATURE UP WITH TYPICAL LOAD	TEST AT SURFACE OF THE CASE WITH TYPICAL AC INPUT AND TYPICAL LOAD IN OUTPUT 50/60Hz	TEMPERATURE UP UNDER 35 DEGREES
HI-POT TEST	INPUT TO OUTPUT GRADUALLY RAISED FROM 0 TO THE 4242Vdc/3000Vac AND HELD AT THAT VALUE FOR 1Minute,10mA	NO DAMAGE
INSULATION RESISTANCE	INPUT TO OUTPUT,DC 500V	>50M Ω
MTBF	TYPICAL INPUT&FULL LOAD,25 $^{\circ}$ C	50000HOURS
LIFE	TYPICAL INPUT&FULL LOAD,40 $^{\circ}$ C TYPICAL INPUT&FULL LOAD,25 $^{\circ}$ C	1YEARS ABOVE 2YEARS ABOVE
BURN-IN	AT 30 $^{\circ}$ C(\pm 10 $^{\circ}$ C),NORMAL INPUT VOLTAGE	2~4 HOURS

5、ENVIRONMENT

ITEM	SPECIFICATION OR TEST CONDITION	min.	typ.	max.
OPERATING TEMPERATURE		0 $^{\circ}$ C		40 $^{\circ}$ C
STORAGE TEMPERATURE		-20 $^{\circ}$ C		85 $^{\circ}$ C
OPERATING HUMIDITY	NON-CONDENSING	5%RH		90%RH
STORAGE HUMIDITY	NON-CONDENSING	5%RH		90%RH

[Http:www.uniontop.com.cn](http://www.uniontop.com.cn)

CHINA TEL:+86-755-89600803 89797300 FAX:+86-755-89600969



DESCRIPTION

Switching Power
Supply

SHEET NO.

4 OF 10

VER:

A/1

MODEL NO.

UT18-090200U

PART NO.

6、OUTLOOKING

DIMENSION :73.5(L)*40(W)*28.5(H)mm

WEIGHT : ABOUT 87.2g

AC INPUT TYPE :WALL MOUNT

DC OUTPUT TYPE :5.5*2.5*10 S TYPE



DC OUTPUT CABLE :UL2468 22AWG/2C BLACK

INDICATION : LABEL

CASE MATERIAL : ABS+PC

PCB MATERIAL :/

7、SAFETY

Item	Country	Certified	Standard	Present
UL	USA		UL60950-1 2 nd	<input type="checkbox"/>
CUL	Canada		CSA C22.2 NO.60950-1	<input type="checkbox"/>
FCC	USA		PART 15 CLASS B	<input type="checkbox"/>
VDE/GS	Europe		EN 60950-1 2 nd	<input type="checkbox"/>
CE	Europe		EN 60950-1 2 nd	<input type="checkbox"/>
BS/UK	Britain		BS EN 60950-1 2 nd	<input type="checkbox"/>
SAA	Australia		AS/NZS 60950-1	<input type="checkbox"/>
CCC	China		GB4943	<input type="checkbox"/>
Ko	Korea		K60950	<input type="checkbox"/>
PSE	Japan		J60950 (H20)	<input type="checkbox"/>
Others				<input type="checkbox"/>

Http:www.uniontop.com.cn

CHINA TEL:+86-755-89600803 89797300 FAX:+86-755-89600969

8、 DIMENSION

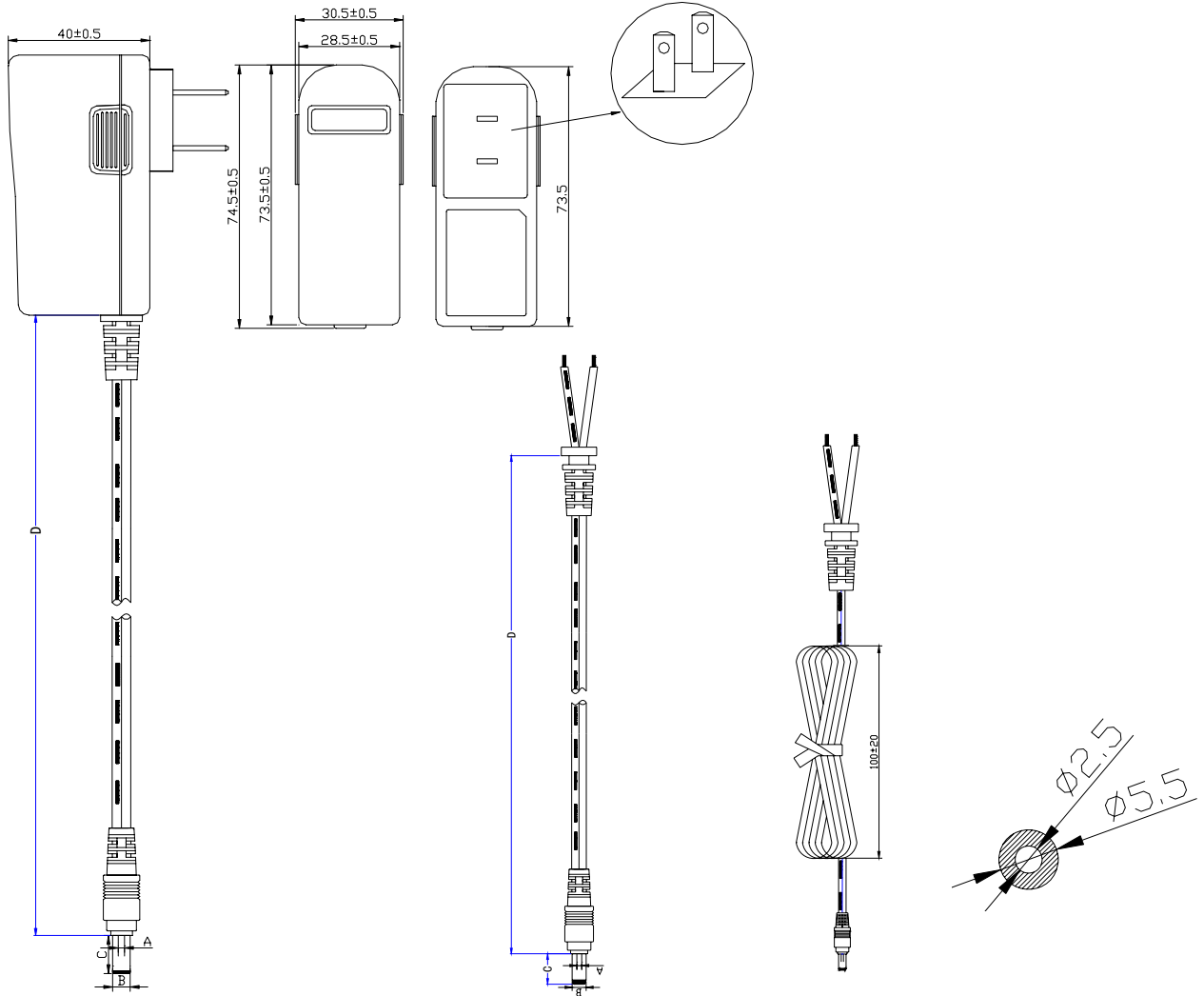

Unit : mm

	ΦA	ΦB	C	D
DIMENSION	2.5	5.5	10	1200
TOLERANCE	+0.1/-0	±0.1	±0.5	±50
REMARK	AWG22/2C UL2468 BLACK			



DESCRIPTION

Switching Power
Supply

SHEET NO.

6 OF 10

VER:

A/1

MODEL NO.

UT18-090200U

PART NO.

9、 LABEL

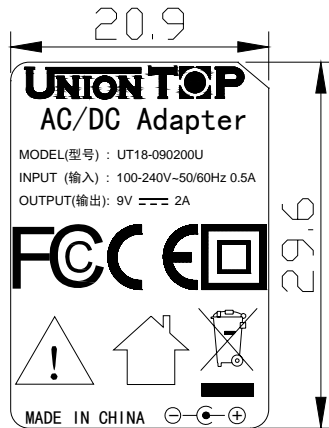

Notes:

1. Thickness: 0.1mm min., inflammation classes 94V-2 or better.
2. Color: **Black background with White letters**
3. Tolerance: -0.2mm

[Http://www.uniontop.com.cn](http://www.uniontop.com.cn)

CHINA TEL:+86-755-89600803 89797300 FAX:+86-755-89600969

10、PACKING

PRUDUCT/产品:

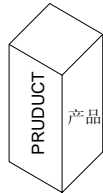

WHITE BOX/小白盒:

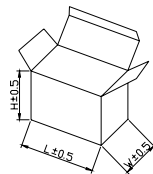

PAPERBOARD/平卡:

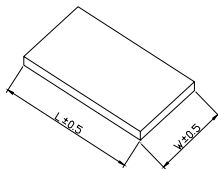

CARTON/纸箱:

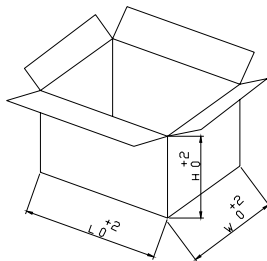

DIMENSION(UNIT IN cm):

	L	W	H
WHITE BOX	9.5	8.0	3.5
PAPERBOARD	49.0	41.5	/
CARTON	50.0	42.5	31.0

PACKING METHOD:

PAPERBOARD PLACEMENT METHOD	PUT A PAPERBOARD BETWEEN THE TOP AND BOTTOM,TOTAL 2PCS
PACKING METHOD	25PCS/LAYER X 8 LAYERS
QTY	200PCS
N.W.	87.2g
G.W.	19.5kg

REMARK:

1. STORAGE CONDITION

TEMPERATURE: -10℃~+60℃ RELATIVE HUMIDITY: 30%~80%

2. STORAGE PERIOD: 6 MONTHES

3. ANLISTATIG: NO REQUIREMENT

4. PLEASE ADVISE IF ANY COMMENTS ABOUT THE PACKING INFORMATION.

OTHERWISE,THIS INFORMATION IS DEFAULTED AS CUSTOMER APPROVAL,AND WILL BE APPLIED TO PRODUCTION.



DESCRIPTION

Switching Power
Supply

SHEET NO.

8 OF 10

VER:

A/1

MODEL NO.

UT18-090200U

PART NO.

11、QC CHECK

ALL OF THE QUANTITY SHALL BE CHECKED BEFORE SHIPMENT,CHECK ITEM AS BELOW:

- (1) DC PLUG POLE CHECK
- (2) OCP FUNCTION CHECK
- (3) DC OUTPUT VOLTAGE CHECK
- (4) HIPOT&INSULATION CHECK
- (5) OUTLOOKING CHECK

12、SAMPLE PRIMARY TEST REPORT

Test Items.	Test Condition	Unit	Sample Number and Test Result										Pass/ Fail	
			1#	2#	3#	4#	5#	6#	7#	8#	9#	10#		
Unload output voltage/(0.0A) <u>9±5%Vdc</u>	100Vac	V												PASS
	240Vac	V												PASS
Rated load output voltage/(<u>2.0A</u>) <u>9±5%Vdc</u>	100Vac	V												PASS
	240Vac	V												PASS
Output ripple & noise voltage≤ <u>300mV</u> (test at full loading)	100Vac	mV												PASS
	240Vac	mV												PASS
Short-circuit protection test (Short at end of DC plug) (SCP≤ <u>6W</u>)	100Vac	W												PASS
	240Vac	W												PASS
Overcurrent Protection (OCP≤ <u>5A</u>)	100Vac	A												PASS
	240Vac	A												PASS
Efficiency test ($\eta \geq$ <u>65%</u>)	100Vac	%												PASS
	240Vac	%												PASS
Hi-pot test	4242Vdc or 3000Vac10mA/ 1Minute													PASS

NOTES: The products which are no use in the three months need to aging test

三个月内完全不使用的产品需做老化测试

Http:www.uniontop.com.cn

CHINA TEL:+86-755-89600803 89797300 FAX:+86-755-89600969



DESCRIPTION	Switching Power Supply	SHEET NO.	9 OF 10
		VER:	A/1
	MODEL NO.	UT18-090200U	PART NO.

13、SAMPLE TEST REPORT

Items No	Test Items	Unit	Test condition & result				Spec. Limit	Pass/ Fail
			90Vac 60Hz	115Vac 60Hz	230Vac 50Hz	264Vac 50Hz		
1	Unload input current	mA					—	-
2	Unload input power	W					≤ <u>0.5W</u>	PASS
3	Rated load input current	mA					≤ <u>500mA</u>	PASS
4	Rated load input power	W					—	-
5	Unload output voltage(0.0A)	V					<u>9±5%</u> Vdc	PASS
6	Rated load output voltage(<u>2.0 A</u>)	V					<u>9±5%</u> Vdc	PASS
7	Rated load Output ripple&noise voltage (<u>300mV</u>)	mV					≤ <u>300mV</u> p-p	PASS
8	Short-circuit test (Pin&lout)	W					≤ <u>6W</u>	PASS
9	Over current protection	A					OCP ≤ <u>5A</u>	PASS
10	Output overshoot	%					≤ <u>10%</u>	PASS
11	Turn on delay time	mS	/	/	/	/	≤ <u>3000mS</u>	-
12	Hold up time	mS	/	/	/	/	≥10mS/(115Vac) ≥20mS/(230Vac)	-
13	Efficiency	%					≥ <u>65%</u>	PASS
14	Hi-pot test	Pri. to Sec. : 4242Vdc or 3000Vac, 1Minute, Cut off current ≤10mA						PASS
15	Max. and Light load change test	Max. load to Light load: OK Light load to max. load: OK (90-264Vac)						
16	Burn-in	Burn-in 4 Hrs, The sample OK						
17	Appe. label and fusion	Appearance: <u>OK</u> , Label: <u>OK</u> , Fusion: <u>OK</u>						

Http:www.uniontop.com.cn

CHINA TEL:+86-755-89600803 89797300 FAX:+86-755-89600969



DESCRIPTION

Switching Power
Supply

SHEET NO.

10 OF 10

VER:

A/1

MODEL NO.

UT18-090200U

PART NO.

14、ENERGY STAR TEST REPORT

Items No.	Test parameter	Unit	Input voltage 115Vac/60Hz						Spec. Limit	Pass /Fail
			100%	75%	50%	25%	0%	Aver.Eff		
1	Input current	mA							$\leq 500\text{mA}$	Pass
2	Input power	W							-	-
3	Output current	A							-	-
4	Output voltage	V							-	-
5	Power factor	-	/	/	/	/			-	-
6	Efficiency	%							$\geq 65\%$	Pass

Items No.	Test parameter	Unit	Input voltage 230Vac/50Hz						Spec. Limit	Pass /Fail
			100%	75%	50%	25%	0%	Aver.Eff.		
1	Input current	mA							$\leq 500\text{mA}$	Pass
2	Input power	W							-	-
3	Output current	A							-	-
4	Output voltage	V							-	-
5	Power factor	-	/	/	/	/			-	-
6	Efficiency	%							$\geq 65\%$	Pass

Note: 1. Aver.Eff.Spec.($\geq 65\%$ Unload input power Spec.($\leq 0.5\text{W}$)for CEC LEVEL/)

Http:www.uniontop.com.cn

CHINA TEL:+86-755-89600803 89797300 FAX:+86-755-89600969